

ZXL20i-IP

LED Image Projector . ZX20 Series



Product Features

- LED image projector using GOBO, color filter or colorizer for outdoor or indoor application.
- ETL outdoor wet location listed. IP65 standard.
- Machined from solid billet 6061-T6 corrosion resistant aluminum.
- 180° vertical and 360° horizontal adjustment via unique swivel stem design.
- Modular components - field changeable LED module & GOBO accessories.
- Line voltage input with integral LED driver in fixture housing.

Specification

Materials: Machined from billet 6061-T6 corrosion resistant aluminum with 304 stainless steel hardware. Available in 304/316 stainless steel or 360 brass upon request.

Glare Shield: 3 optional glare shields(GSL-long, GSA-angled GSS-short) for additional glare control. See page 3 for details.

Voltage: Universal 120~277V AC with integral LED driver.

Wattage: 21W HK LED.

Light Source: CRI 83. Available in CRI95 upon request. The chromaticity range is within a 3-step McAdam Ellipse. Standard CCT options are 2700K, 3000K, 4000K.

Lamp Base/Socket: Innovative cone-shaped lamp base and receptacle socket maximize the surface contact area to dissipate heat more effectively. See "Resources" for details.

Dimmability: Phase dimming @120V, or 0-10V dimming @ 120~277V. Please consult factory for DALI or DMX control.

Finish: Polyester powder coat on all aluminum materials with RoHS compliant procedures. Anodized finish is available. Stainless steel and brass models are provided with brushed surface.

Optical Accessories: Accepts combinations of accessories (including colorizer, color filters, steel gobo etc.). Secured in place with metal snap ring.

Mounting Method : Mounts using 1/2"-14 NPS male fitting compatible with all HK Lighting Group mounting devices.

GOBO Size : See data on second page.

Ordering Guide

EXAMPLE: ZXL20i-IP - GSL - UNV - 21 - 27 - BK - GOBO - CMS

SERIES	MATERIAL	OPTIONAL GLARE SHIELD	VOLTAGE	WATTAGE	CCT	FINISH	OPTIONAL OPTIC ACCESSORIES	OPTIONAL MOUNTING ACCESSORIES
ZXL20i-IP	-	-	-	-	-	-	-	-
	BLANK Aluminum(Standard)	GSL	120V 120V (Phase Control)	21 21W	27 2700K	Standard	GOBO Gobo	See page 3 for quick reference, or "Accessories" link for detailed specification.
	NBR Natural Brass	GSA	UNV 120~277V (0-10V)	30 3000K	BK Black Powder Coat	CR Colorizer		
	NSS Natural Stainless Steel	GSS		40 4000K	BZ Bronze Powder Coat	CF Color filter		
	CU Natural Copper				WT White Powder Coat			
					Premium ABK Anodized Black ACL Anodized Clear CC Custom Powder Coat			

Product Drawings

NOTE: Specification and dimensions subject to change without notice.

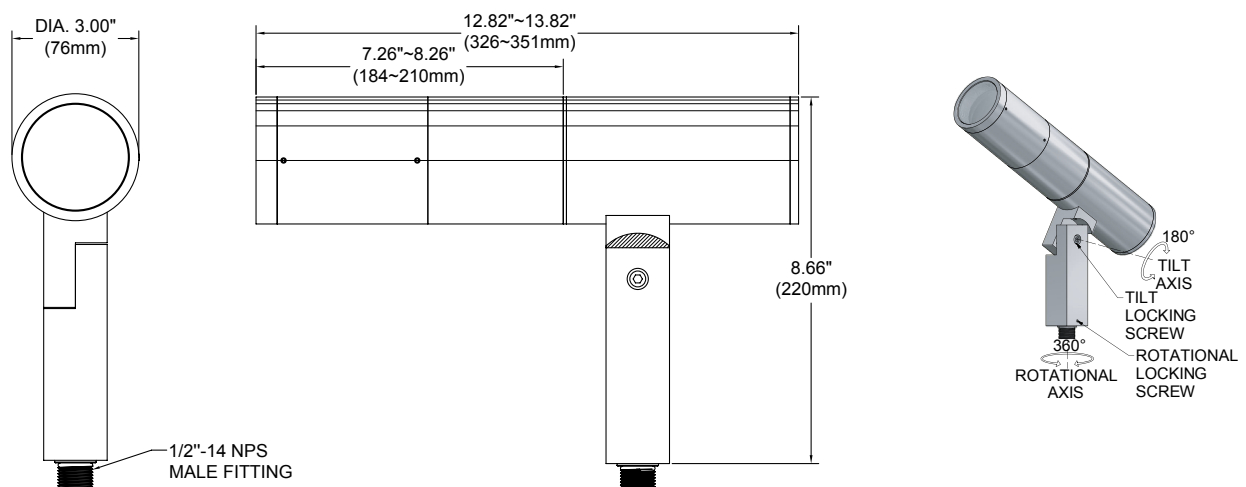

Photometry & Energy Data

MODEL ZXL20i-IP-21W

Input Power	21W
Color Temperature (CCT)	3000K
Color Rendering Index (Ra)	83
Projection Angle	50°
Delivered Lumen	to follow

Cone Of Image

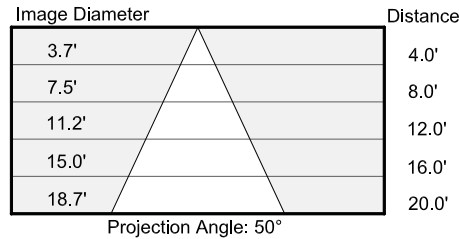

Wattage Multiplier Table

Wattage	Multiplier
21Watt	1.00

CCT Multiplier Table

Color Temp.	Multiplier
2700k	0.97
3000k	1.00
4000k	1.05

Typical Data

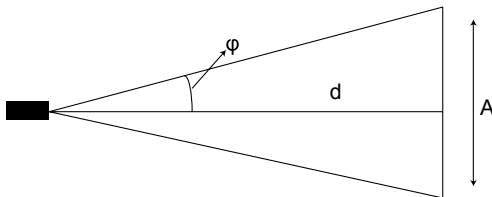

$\tan \phi = 0.5 A / d$
 d = distance between fixture and projection plan
 A = diameter if the projected image
 2ϕ = projection angle

Image Projector Size	Projection angle	GOBO size in mm (OD/IA)	Watt	Input Volt
ZXL08	28°	20/13(Rosco 518)	3	12 Vac
ZXL11	28°	27.5/22(Rosco Mac500/918)	5, 7	12 Vac
ZXL16/16i	40°	36.3/31(Rosco Studio Spot 575)	7, 10	12 Vac/ Line Volt
ZX16/16i-SOi	40°	36.3/31(Rosco Studio Spot 575)	7.5, 9	12 Vac/ Line Volt
ZXL18i	40°	36.3/31(Rosco Studio Spot 575)	17	Line Volt
ZXL20i	50°	53.3/38(Rosco size D)	21, 28	Line Volt
ZXL30i	50°	100/75(Rosco size A)	41	Line Volt
ZXL38i	50°	100/75(Rosco size A)	52	Line Volt

Note: Data may vary due to different focal length of lens or IA of GOBO.

Product Options & Accessories

Optional Glare Shield

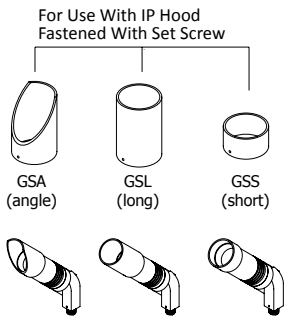

Mounting Accessories

Canopy Plate:

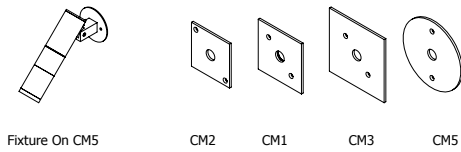

Surface Mount Box:

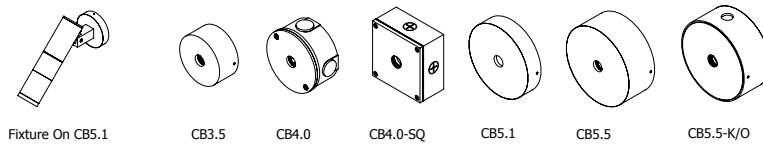

Ground Mount:

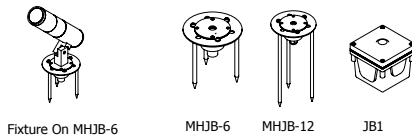

Tree Mount:

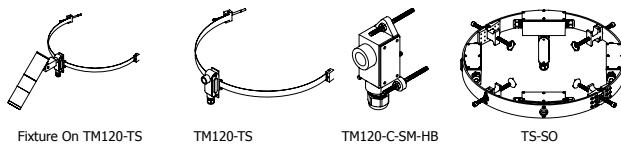

Extension:

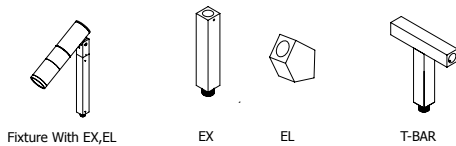

Sign Light Arm:

Please See The Sign Light Section

Notes