

ZXL11-SQ

LED Area Accent · ZX11 Series

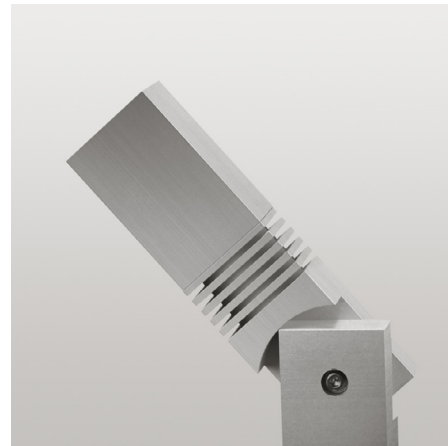

Product Features

- Area accent lighting for architectural and landscape application.
- ETL outdoor wet location listed. IP67 standard.
- Machined from solid billet 6061-T6 corrosion resistant aluminum.
- 180° vertical and 360° horizontal adjustment via unique swivel stem design.
- Modular components - field changeable LED module & beam spread reflectors.

Specification

Materials: Machined from billet 6061-T6 corrosion resistant aluminum with 304 stainless steel hardware. Available in 304/316 stainless steel or 360 brass upon request.

Glare Shield: 3 optional glare shields(GSL-long, GSA-angled GSS-short) for additional glare control. See page 3 for details.

Voltage: 12V AC/DC. Requires remote step down transformer.

Wattage: 5, 7W HK LED.

Light Source: CRI 83. Available in CRI95 upon request. The chromaticity range is within a 3-step McAdam Ellipse. Standard CCT options are 2700K, 3000K, 4000K.

Lamp Base/Socket: Innovative cone-shaped lamp base and receptacle socket maximize the surface contact area to dissipate heat more effectively. See "Resources" for details.

Dimmability: MLV or ELV.

Finish: Polyester powder coat on all aluminum materials with RoHS compliant procedures. Anodized finish is available. Stainless steel and brass models are provided with brushed surface.

Optical Accessories: Accepts up to 3 accessories (hexcel louver, optical lenses, dichroic color filters, etc.). Secured in place with metal snap ring.

Mounting Method: Mounts using 1/2"-14 NPS male fitting compatible with all HK Lighting Group mounting devices.

Ordering Guide

EXAMPLE: ZXL11-SQ - GSL - 12V - 7 - 27 - 40 - BK - LVR - MH02

SERIES	MATERIAL	OPTIONAL GLARE SHIELD	VOLTAGE	WATTAGE	CCT	OPTICS	FINISH	OPTIONAL SELECT UP TO 3 OPTIC ACCESSORIES	OPTIONAL MOUNTING ACCESSORIES
ZXL11-SQ	-	-	12V	-	-	-	-	-	-
	BLANK Aluminum(Standard) NBR Natural Brass NSS Natural Stainless Steel CU Natural Copper	GSL GSA GSS		5 5W 7 7W	27 2700K 30 3000K 40 4000K	29 29° 40 40° 57 57°	Standard BK Black Powder Coat BZ Bronze Powder Coat WT White Powder Coat Premium ABK Anodized Black ACL Anodized Clear CC Custom Powder Coat	LVR Hexcel Louver OSL Overall Spread Lens LSL Linear Spread Lens SQL Solite Soft Focus DF Dichroic Filter	See page 3 for quick reference, or "Accessories" link for detailed specification.

Remote Step Down Transformer (Optional).
See "Accessories" link for detailed specification.

Model	Wattage(VA)	Primary Voltage(VAC)	Secondary Volt(VAC)	Dimming Method	Characters
-	-	-	-	-	-
TXM	20 40 60 100 150 300	120 or 277	12	MLV	Outdoor, Wall Mount, Compact
TXS	150 300 600	120	Multi-tap of 12, 13, 14, 15 VAC	MLV	Outdoor, Wall mount, Stainless Steel Case
IGT	50(120V only) 100 300 600	120 or 277	12	MLV	in grade
TXE	60	120, 230, or 277	12	ELV	Needs Enclosure, 6ft working distance

Product Drawings

NOTE: Specification and dimensions subject to change without notice.

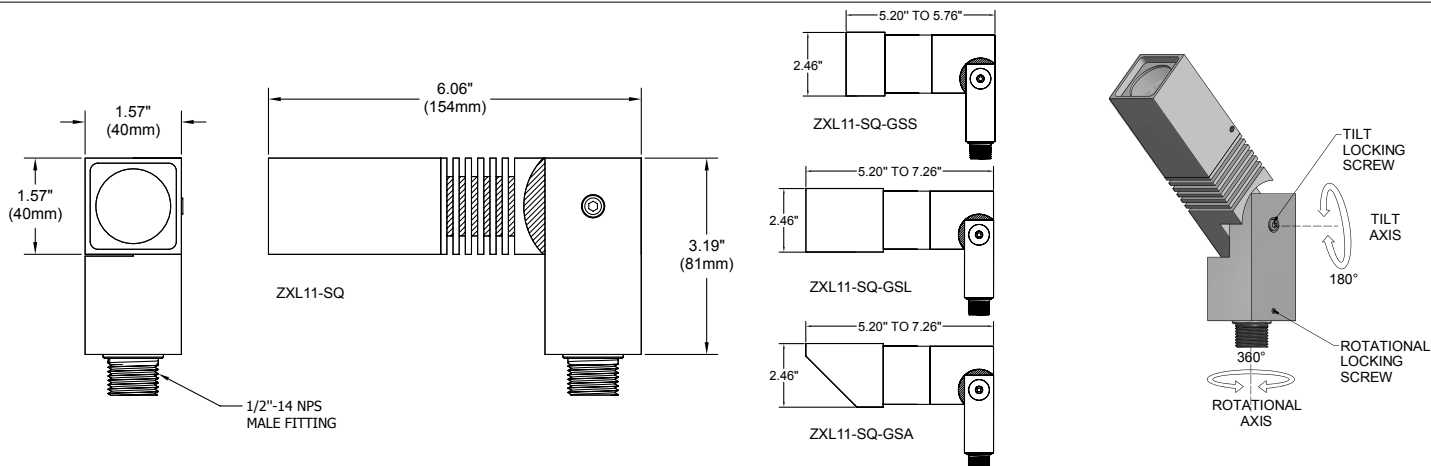

Photometry & Energy Data

MODEL ZXL11-SQ-7W-N

Input Power	8.1W
Color Temperature (CCT)	3000K
Color Rendering Index (Ra)	80
Beam Angle	28.7°
Max. Candlepower	1964cd
Delivered Lumens	636lm
Efficacy	78lm/W

Polar Graph - Intensity

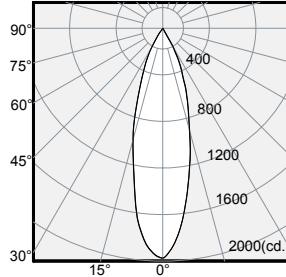

Cone of Light - Illuminance

Center Beam (fc)	Beam Diameter	Distance
491	1.0'	2.0'
123	2.0'	4.0'
55	3.0'	6.0'
31	4.0'	8.0'
20	5.0'	10.0'

1/2 Beam Angle: 28.7°

MODEL ZXL11-SQ-7W-M

Input Power	8.1W
Color Temperature (CCT)	3000K
Color Rendering Index (Ra)	80
Beam Angle	39.2°
Max. Candlepower	1383cd
Delivered Lumen	632lm
Efficacy	78lm/W

Polar Graph - Intensity

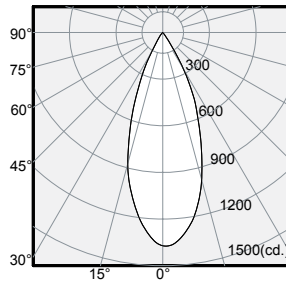

Cone of Light - Illuminance

Center Beam (fc)	Beam Diameter	Distance
346	1.4'	2.0'
86	2.9'	4.0'
38	4.3'	6.0'
22	5.7'	8.0'
14	7.1'	10.0'

1/2 Beam Angle: 39.2°

MODEL ZXL11-SQ-7W-W

Input Power	8.1W
Color Temperature (CCT)	3000K
Color Rendering Index (Ra)	80
Beam Angle	56.9°
Max. Candlepower	811cd
Delivered Lumen	675lm
Efficacy	83lm/W

Polar Graph - Intensity

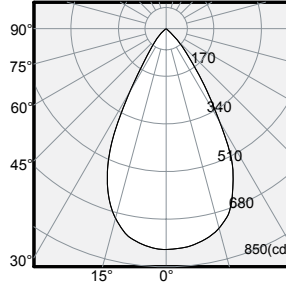

Cone of Light - Illuminance

Center Beam (fc)	Beam Diameter	Distance
203	2.2'	2.0'
135	4.3'	4.0'
23	6.5'	6.0'
13	8.7'	8.0'
8	10.8'	10.0'

1/2 Beam Angle: 56.9°

Wattage Multiplier Table

Wattage	Multiplier
5Watt	0.67
7Watt	1.00

CCT Multiplier Table

Color Temp.	Multiplier
2700K	0.96
3000K	1.00
4000K	1.03

Product Options & Accessories

Optional Glare Shield

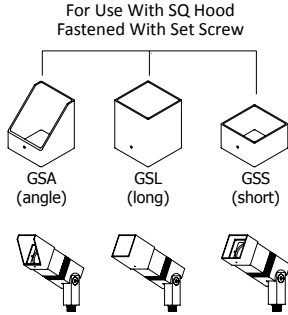

Mounting Accessories

Canopy Plate:

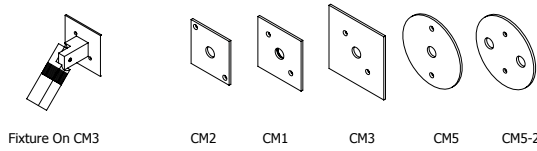

Surface Mount Box:

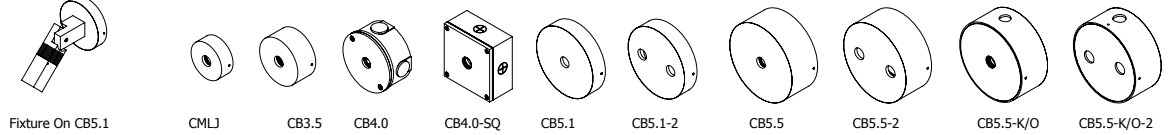

Ground Mount:

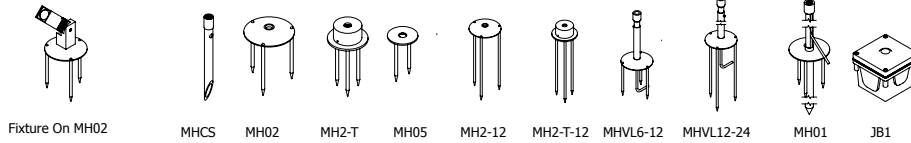

Tree Mount:

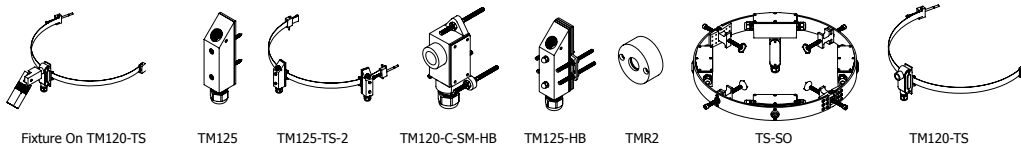

Extension:

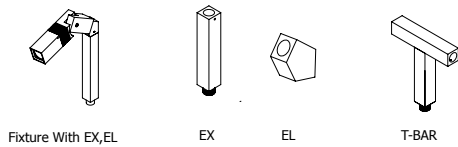

Sign Light Arm: Please See The Sign Light Section

Notes