

# ZXL16i-FIT

LED Area Accent . FIT Series



## Product Features

- Area accent lighting for architectural and landscape application.
- ETL outdoor wet location listed. IP67 standard.
- Machined from solid billet 6061-T6 corrosion resistant aluminum.
- 180° vertical and 360° horizontal adjustment via unique swivel stem design.
- Modular components - field changeable LED module & beam spread reflectors.
- Line voltage input with integral LED driver in fixture housing.

- Innovative new hood design utilizes convection cooling to reduce temperatures more effectively than traditional methods.

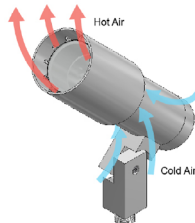

## Specification

**Materials:** Machined from billet 6061-T6 corrosion resistant aluminum with 304 stainless steel hardware.

**Glare Shield:** 2 optional glare shields(GSL-long, GSA-angled) for additional glare control.

**Voltage:** Universal 120~277V AC with integral LED driver.

**Wattage:** 20W HK LED.

**Light Source:** CRI 83. Available in CRI95 upon request. The chromaticity range is within a 3-step McAdam Ellipse. Standard CCT options are 2700K, 3000K, 4000K.

**Lamp Base/Socket:** Innovative cone-shaped lamp base and receptacle socket maximize the surface contact area to dissipate heat more effectively. See "Resources" for details.

**Dimmability:** Phase dimming at 120V(standard), 0-10V dimming @120~277V.

**Finish:** Polyester powder coat on all aluminum materials with RoHS compliant procedures. Anodized finish is available.

**Optical Accessories:** Accepts up to 3 accessories (hexcel louver, optical lenses, dichroic color filters, etc.). Secured in place with metal snap ring.

**Mounting Method:** Mounts using 1/2"-14 NPS male fitting compatible with all HK Lighting Group mounting devices.

## Ordering Guide

EXAMPLE: ZXL16i-FIT - GSL - UNV - 20 - 27- 19 - PH - BK - LVR - CMS

SERIES	MATERIAL	OPTIONAL GLARE SHIELD	VOLTAGE	WATTAGE	CCT	OPTICS	DIMMING	FINISH	OPTIONAL SELECT UP TO 3 OPTIC ACCESSORIES	OPTIONAL MOUNTING ACCESSORIES	
ZXL16i-FIT	BLANK Aluminum(Standard)	GSL GSA	UNV 120~277V UNIVERSAL	20 20W	27 30 40	2700K 3000K 4000K	19 19° 33 33° 46 46°	PH Phase dimming @120V only 010 0-10V dimming ND non-dimming	Standard BK Black Powder Coat BZ Bronze Powder Coat WT White Powder Coat Premium ABK Anodized Black ACL Anodized Clear CC Custom Powder Coat	LVR Hexcel Louver OSL Overall Spread Lens LSL Linear Spread Lens SOL Solite Soft Focus DF Dichroic Filter	See page 3 for quick reference, or "Accessories" link for detailed specification.

## Product Drawings

NOTE: Specification and dimensions subject to change without notice.

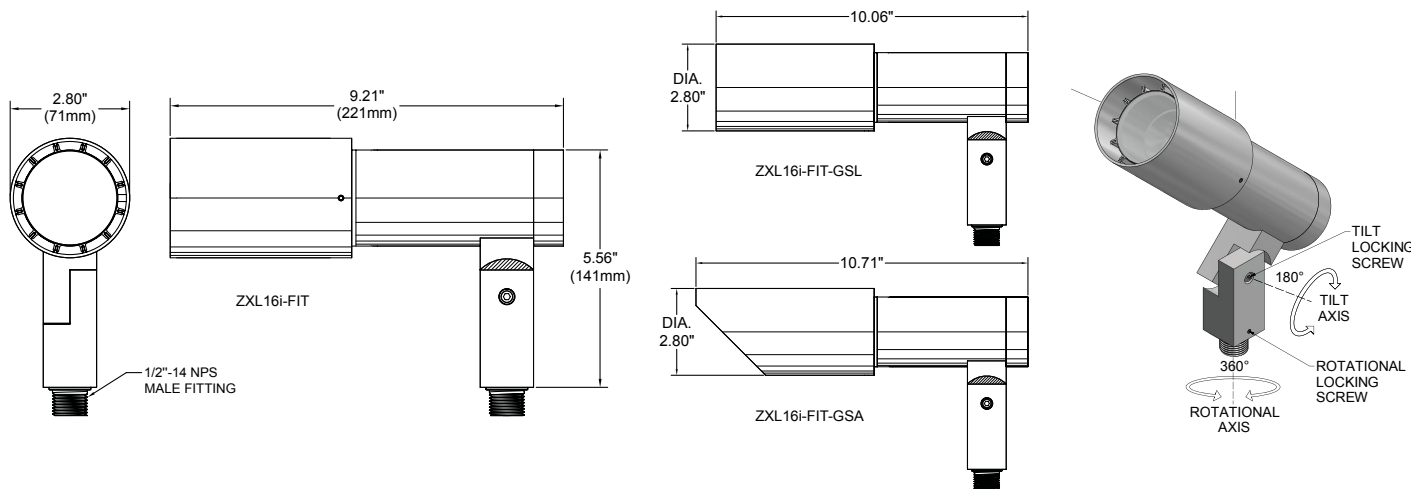

## Photometry & Energy Data

MODEL **ZXL16i-FIT-20W-N**

Input Power	20.0W
Color Temperature (CCT)	3000K
Color Rendering Index (Ra)	83
Beam Angle	19.1°
Max. Candlpower	7567cd
Delivered Lumens	1965lm
Efficacy	98lm/W

Polar Graph - Intensity

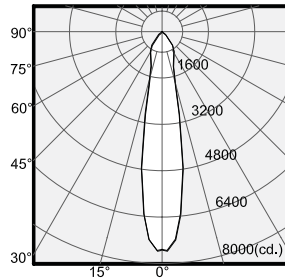

Cone of Light - Illuminance

Center Beam (fc)	Beam Diameter	Distance
1892	0.7'	2.0'
473	1.3'	4.0'
210	2.0'	6.0'
118	2.7'	8.0'
76	3.4'	10.0'

1/2 Beam Angle: 19.1°

MODEL **ZXL16i-FIT-20W-M**

Input Power	19.9W
Color Temperature (CCT)	3000K
Color Rendering Index (Ra)	83
Beam Angle	32.5°
Max. Candlpower	4119cd
Delivered Lumen	1901lm
Efficacy	96lm/W

Polar Graph - Intensity

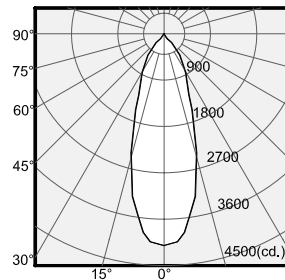

Cone of Light - Illuminance

Center Beam (fc)	Beam Diameter	Distance
1030	1.2'	2.0'
257	2.3'	4.0'
114	3.5'	6.0'
64	4.7'	8.0'
41	5.8'	10.0'

1/2 Beam Angle: 32.5°

MODEL **ZXL16i-FIT-20W-W**

Input Power	19.9W
Color Temperature (CCT)	3000K
Color Rendering Index (Ra)	83
Beam Angle	45.9°
Max. Candlpower	2913cd
Delivered Lumen	1899lm
Efficacy	95lm/W

Polar Graph - Intensity

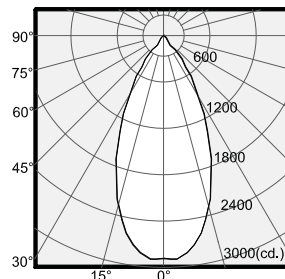

Cone of Light - Illuminance

Center Beam (fc)	Beam Diameter	Distance
728	1.7'	2.0'
182	3.4'	4.0'
81	5.1'	6.0'
46	6.8'	8.0'
29	8.5'	10.0'

1/2 Beam Angle: 45.9°

CCT Multiplier Table

Color Temp.	Multiplier
2700K	0.97
3000K	1.00
4000K	1.05

**Mounting Accessories**

**Canopy Plate:**

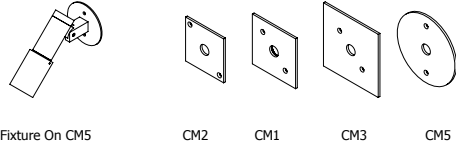

Fixture On CM5

CM2 CM1 CM3 CM5

**Surface Mount Box:**

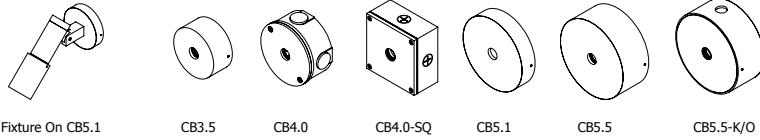

Fixture On CB5.1

CB3.5 CB4.0 CB4.0-SQ CB5.1 CB5.5 CB5.5-K/O

**Ground Mount:**

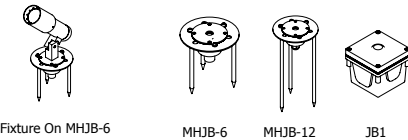

Fixture On MHJB-6

MHJB-6 MHJB-12 JB1

**Tree Mount:**

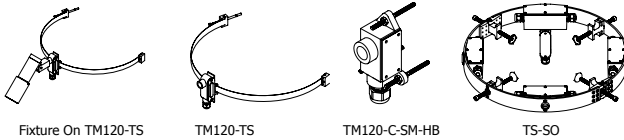

Fixture On TM120-TS

TM120-TS TM120-C-SM-HB TS-SO

**Extension:**

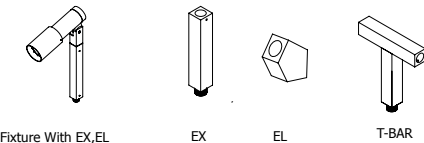

Fixture With EX,EL

EX EL T-BAR

**Sign Light Arm:**

Please See The Sign Light Section

**Notes**