

ZXL20i-FIT

LED Area Accent . FIT Series



Product Features

- Area accent lighting for architectural and landscape application.
- ETL outdoor wet location listed. IP67 standard.
- Machined from solid billet 6061-T6 corrosion resistant aluminum.
- 180° vertical and 360° horizontal adjustment via unique swivel stem design.
- High output up to 3060 delivered lumens.
- Can accommodate HK LED, Xicato LED, Lumenetix tunable white LED.
- Line voltage input with integral LED driver in fixture housing.

- Innovative new hood design utilizes convection cooling to reduce temperatures more effectively than traditional methods.

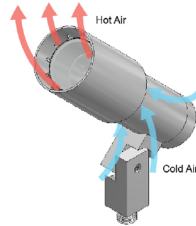

Specification

Materials: Machined from billet 6061-T6 corrosion resistant aluminum with 304 stainless steel hardware.

Glare Shield: 2 optional glare shields(GSL-long, GSA-angled) for additional glare control.

Voltage: Universal 120~277V AC with integral LED driver.

Wattage: 21,28 or 31W HK LED. 17W or 28W for Xicato LED, 20W for tunable white LED.

Light Source: 3 options of high quality LED are selected for ZXL20i. Nichia LED with high efficacy; Xicato LED with 5-year warranty on color consistency (Prefix "X" in wattage selection), and Lumenetix for tunable white LED (Prefix "TW" in wattage selection). CRI 83. Available in CRI 95 upon request.

Lamp Base/Socket: Innovative cone-shaped lamp base and receptacle socket maximize the surface contact area to dissipate heat more effectively. See "Resources" for details.

Dimmability: Phase dimming at 120V(standard), or 0-10V dimming at 120-277V. DALI dimming, DMX control available, consult factory.

Finish: Polyester powder coat on all aluminum materials with RoHS compliant procedures. Anodized finish is available.

Optical Accessories: Accepts up to 3 accessories (hexcel louver, optical lenses, dichroic color filters, etc.). Secured in place with metal snap ring.

Mounting Accessory: Mounts using 1/2"-14 NPS male fitting compatible with all HK Lighting Group mounting devices.

Ordering Guide

EXAMPLE: ZXL20i-FIT - GSL - UNV - N21 - 27 - 16 - PH - BK - LVR - CMS

SERIES	MATERIAL	OPTIONAL GLARE SHIELD	VOLTAGE	WATTAGE	CCT	OPTICS	DIMMING	FINISH	OPTIONAL SELECT UP TO 3 OPTIC ACCESSORIES	OPTIONAL MOUNTING ACCESSORIES
ZXL20i-FIT	-	-	UNV	-	-	-	-	-	-	-
	BLANK Aluminum(Standard)	GSL	120~277V UNIVERSAL	X17 17W X28 28W N21 21W N28 28W N31 31W TW20 20W	27 2700K 30 3000K 40 4000K Tunable White 1680~8000K	16 16° 26 26° 60 60°	PH Phase dimming @120V only 010 0-10V dimming ND non-dimming	Standard BK Black Powder Coat BZ Bronze Powder Coat WT White Powder Coat Premium ABK Anodized Black ACL Anodized Clear CC Custom Powder Coat	LVR Hexcel Louver OSL Overall Spread Lens LSL Linear Spread Lens SOL Solite Soft Focus DF Dichroic Filter	See page 3 for quick reference, or "Accessories" link for detailed specification.

Product Drawings

NOTE: Specification and dimensions subject to change without notice.

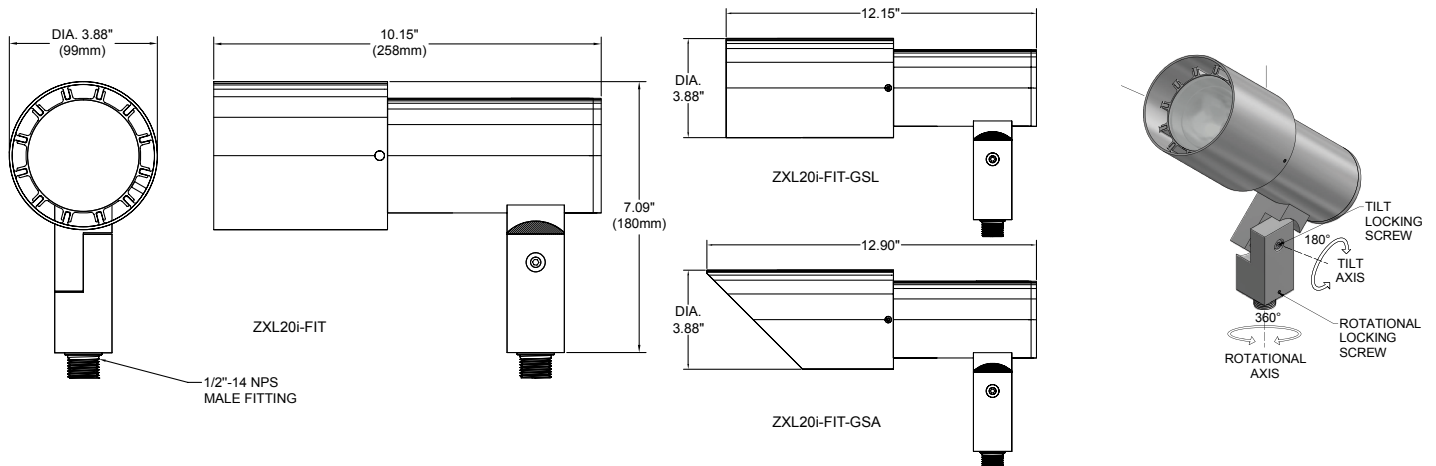

Photometry & Energy Data

MODEL **ZXL20i-FIT-N28W-N**

Input Power	28.2W
Color Temperature (CCT)	3000K
Color Rendering Index (Ra)	83
Beam Angle	16.1°
Max. Candlpower	17751cd
Delivered Lumens	2652lm
Efficacy	94lm/W

Polar Graph - Intensity

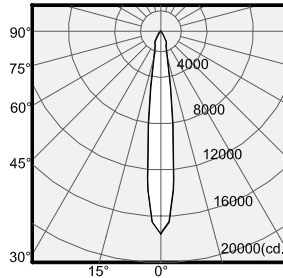

Cone of Light - Illuminance

Center Beam (fc)	Beam Diameter	Distance
4438	0.6'	2.0'
1109	1.1'	4.0'
493	1.7'	6.0'
277	2.3'	8.0'
178	2.8'	10.0'

1/2 Beam Angle: 16.1°

MODEL **ZXL20i-FIT-N28W-M**

Input Power	28.0W
Color Temperature (CCT)	3000K
Color Rendering Index (Ra)	83
Beam Angle	25.5°
Max. Candlpower	9513cd
Delivered Lumen	2702lm
Efficacy	97lm/W

Polar Graph - Intensity

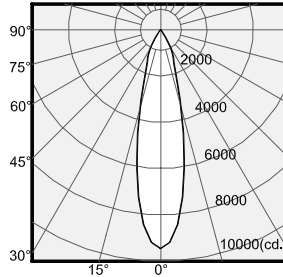

Cone of Light - Illuminance

Center Beam (fc)	Beam Diameter	Distance
2378	0.9'	2.0'
595	1.8'	4.0'
264	2.7'	6.0'
149	3.6'	8.0'
95	4.5'	10.0'

1/2 Beam Angle: 25.5°

MODEL **ZXL20i-FIT-N28W-W**

Input Power	29.0W
Color Temperature (CCT)	3000K
Color Rendering Index (Ra)	83
Beam Angle	60.1°
Max. Candlpower	2926cd
Delivered Lumen	2667lm
Efficacy	92lm/W

Polar Graph - Intensity

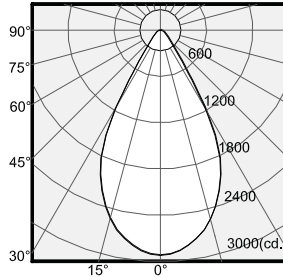

Cone of Light - Illuminance

Center Beam (fc)	Beam Diameter	Distance
731	2.3'	2.0'
183	4.6'	4.0'
81	6.9'	6.0'
46	9.3'	8.0'
29	11.6'	10.0'

1/2 Beam Angle: 60.1°

Wattage Multiplier Table

Type	Wattage	Multiplier
X17	17Watt	0.51
X28	28Watt	0.77
N21	21Watt	0.71
N28	28Watt	1.00
N31	31Watt	1.14
TW20	20Watt	consult factory

CCT Multiplier Table

Color Temp.	Multiplier
2700K	0.97
3000K	1.00
4000K	1.05
Tunable White	consult factory

Mounting Accessories

Canopy Plate:

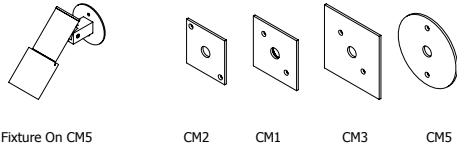

Fixture On CM5 CM2 CM1 CM3 CM5

Surface Mount Box:

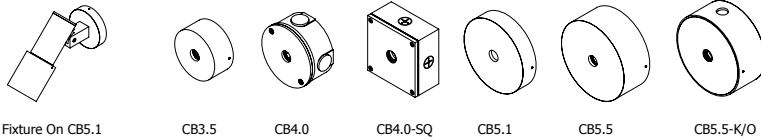

Fixture On CB5.1 CB3.5 CB4.0 CB4.0-SQ CB5.1 CB5.5 CB5.5-K/O

Ground Mount:

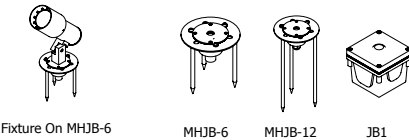

Fixture On MHJB-6 MHJB-6 MHJB-12 JB1

Tree Mount:

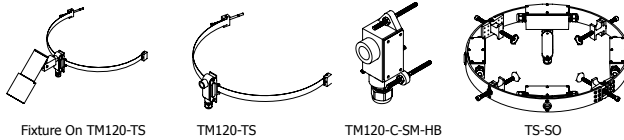

Fixture On TM120-TS TM120-TS TM120-C-SM-HB TS-SO

Extension:

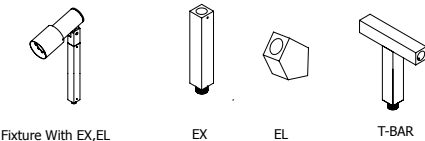

Fixture With EX,EL EX EL T-BAR

Sign Light Arm: Please See The Sign Light Section

Notes