

# ZXL16-WM-SQ-PVT

LED Wall Mount · ZX16 Series

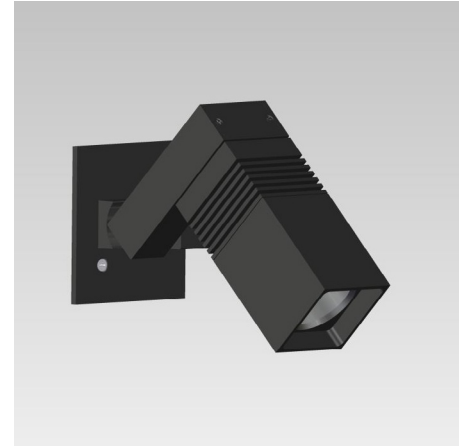

## Product Features

- Adjustable wall mount up light or down light with mounting canopy.
- ETL outdoor wet location listed. IP65 standard.
- Machined from solid billet 6061-T6 corrosion resistant aluminum.
- Swivel stem insert allows for precision adjustment during installation.
- Unique weep hole design in hood allows for either upward or downward facing installation with minimum light leak.
- Modular components - field changeable LED module & beam spread reflectors.

## Specification

**Materials:** Machined from billet 6061-T6 corrosion resistant aluminum with 304 stainless steel hardware. Available in 304/316 stainless steel or 360 brass upon request.

**Glare Shield:** 3 optional glare shields(GSL-long, GSA-angled GSS-short) for additional glare control. See page 3 for details.

**Wattage:** 5, 7 or 10W HK LED. 10W AMBER LED.

**Voltage:** 12V AC/DC. Requires remote step down transformer.

**Light Source:** CRI 83. Available in CRI95 upon request. The chromaticity range is within a 3-step McAdam Ellipse. Standard CCT options are 2700K, 3000K, 4000K.

**Lamp Base/Socket:** Innovative cone-shaped lamp base and receptacle socket maximize the surface contact area to dissipate heat more effectively. See "Resources" for details.

**Dimmability:** MLV or ELV depending on the transformer used.

**Finish:** Polyester powder coat on all aluminum materials with RoHS compliant procedures. Anodized finish is available. Stainless steel and brass models are provided with brushed surface.

**Optical Accessories:** Accepts up to 3 accessories (hexcel louver, optical lenses, dichroic color filters, etc.). Secured in place with metal snap ring.

**Mounting Accessory:** Utilizes 2x 8-32 UNC machine screws (provided) to attach to a standard octagon recessed back box (provided by others).

## Ordering Guide

EXAMPLE: ZXL16-WM-SQ-PVT - GSL - 12V - 5 - 27- 20 - BK - LVR - CM1

SERIES	MATERIAL	OPTIONAL GLARE SHIELD	VOLTAGE	WATTAGE	CCT	OPTICS	FINISH	OPTIONAL SELECT UP TO 3 OPTIC ACCESSORIES	OPTIONAL MOUNTING ACCESSORIES
ZXL16-WM-SQ-PVT	BLANK Aluminum(Standard) NBR Natural Brass NSS Natural Stainless Steel CU Natural Copper	GSL GSA GSS	12V	5 5W 7 7W 10 10W AMB 10W AMBER	27 2700K 30 3000K 40 4000K	20 20° 33 33° 44 44° 57 57°	Standard BK Black Powder Coat BZ Bronze Powder Coat WT White Powder Coat Premium ABK Anodized Black ACL Anodized Clear CC Custom Powder Coat	LVR Hexcel Louver OSL Overall Spread Lens LSL Linear Spread Lens SOL Solite Soft Focus DF Dichroic Filter	See page 3 for quick reference, or "Accessories" link for detailed specification.

Remote Step Down Transformer (Optional).  
See "Accessories" link for detailed specification.

Model	Wattage(VA)	Primary Voltage(VAC)	Secondary Volt(VAC)	Dimming Method	Characters
TXM	20 40 60 100 150 300	120 or 277	12	MLV	Outdoor, Wall Mount, Compact
TXS	150 300 600	120	Multi-tap of 12, 13, 14, 15 VAC	MLV	Outdoor, Wall mount, Stainless Steel Case
IGT	50 100 300 600	120	12	MLV	in grade
TXE	60	120, 230, or 277	12	ELV	Needs Enclosure, 6ft working distance

## Product Drawings

NOTE: Specification and dimensions subject to change without notice.

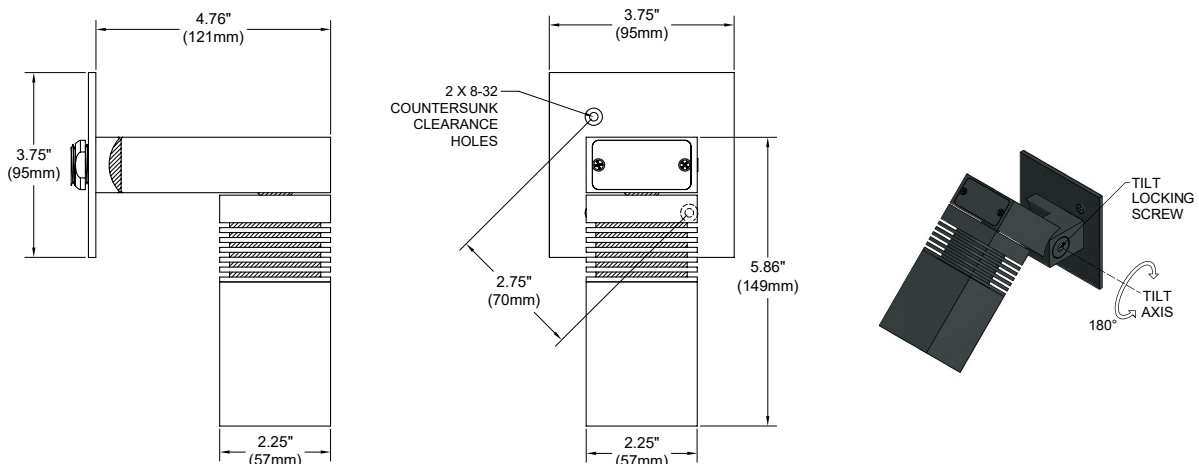

## Photometry & Energy Data

MODEL **ZXL16-WM-SQ-PVT-10W-N**

Inout Power	9.5W
Color Temperature (CCT)	3000K
Color Rendering Index (Ra)	83
Beam Angle	20.5°
Max. Candlpower	3507cd
Delivered Lumens	864lm
Efficacy	91lm/W

Polar Graph - Intensity

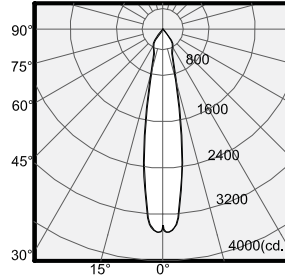

Cone of Light - Illuminance

Center Beam (fc)	Beam Diameter	Distance
877	0.7'	2.0'
219	1.4'	4.0'
97	2.2'	6.0'
55	2.9'	8.0'
35	3.6'	10.0'

1/2 Beam Angle: 20.5°

MODEL **ZXL16-WM-SQ-PVT-10W-M**

Inout Power	9.5W
Color Temperature (CCT)	3000K
Color Rendering Index (Ra)	83
Beam Angle	32.5°
Max. Candlpower	1842cd
Delivered Lumen	863lm
Efficacy	91lm/W

Polar Graph - Intensity

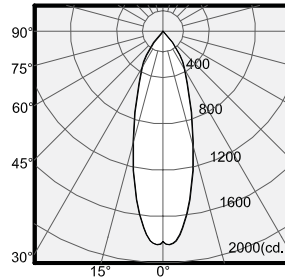

Cone of Light - Illuminance

Center Beam (fc)	Beam Diameter	Distance
460	1.2'	2.0'
115	2.3'	4.0'
51	3.5'	6.0'
29	4.6'	8.0'
18	5.8'	10.0'

1/2 Beam Angle: 32.5°

MODEL **ZXL16-WM-SQ-PVT-10W-W**

Inout Power	9.5W
Color Temperature (CCT)	3000K
Color Rendering Index (Ra)	83
Beam Angle	44.1°
Max. Candlpower	1332cd
Delivered Lumen	850lm
Efficacy	89lm/W

Polar Graph - Intensity

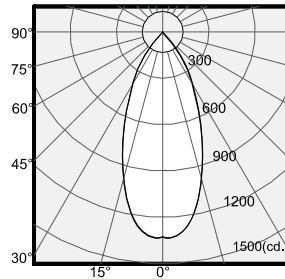

Cone of Light - Illuminance

Center Beam (fc)	Beam Diameter	Distance
333	1.6'	2.0'
83	3.2'	4.0'
37	4.9'	6.0'
21	6.5'	8.0'
13	8.1'	10.0'

1/2 Beam Angle: 44.1°

MODEL **ZXL16-WM-SQ-PVT-10W-VW**

Inout Power	9.5W
Color Temperature (CCT)	3000K
Color Rendering Index (Ra)	83
Beam Angle	56.9°
Max. Candlpower	1019cd
Delivered Lumen	876lm
Efficacy	92lm/W

Polar Graph - Intensity

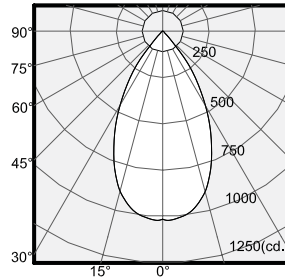

Cone of Light - Illuminance

Center Beam (fc)	Beam Diameter	Distance
255	2.3'	2.0'
64	4.6'	4.0'
28	6.9'	6.0'
16	9.2'	8.0'
10	11.5'	10.0'

1/2 Beam Angle: 56.9°

### Wattage Multiplier Table

Wattage	Multiplier
5Watt	0.53
7Watt	0.77
10Watt	1.00
AMBER 10W	0.73

### CCT Multiplier Table

Color Temp.	Multiplier
2700K	0.97
3000K	1.00
4000K	1.05

## Product Options & Accessories

### Optional Glare Shield

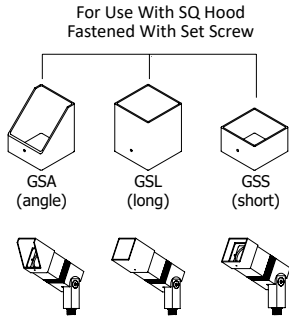

### Mounting Accessories

#### Canopy Plate:

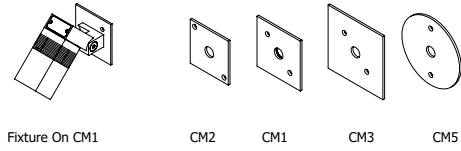

#### Surface Mount Box:

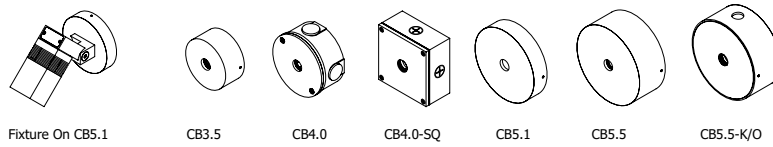

### Notes